

Metal Detection Guide

From your Metal Detection Experts at
ADVANCED DETECTION SYSTEMS

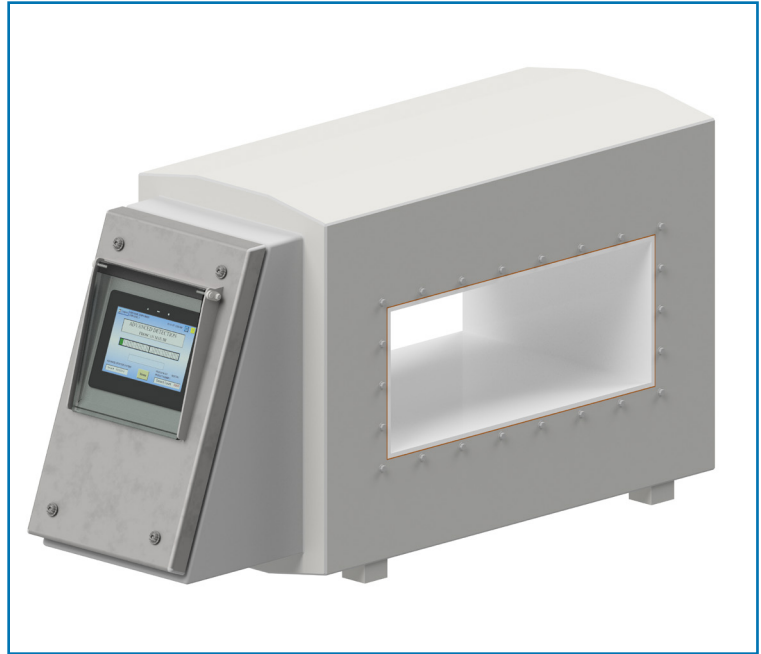
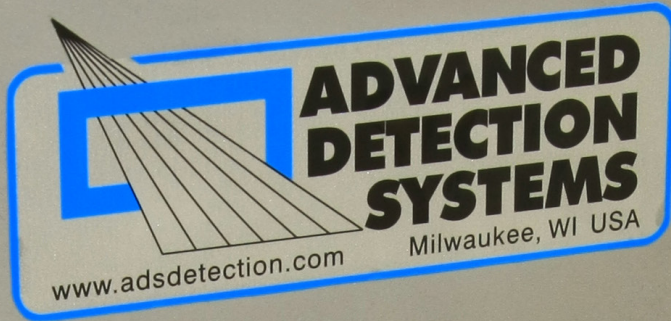

What's Inside?

- ◇ Metal Detection Principals
- ◇ The 4 "P"s of Metal Detection
- ◇ Testing Metal Detector Performance
- ◇ Sources of Interference
- ◇ Applications
- ◇ Good Manufacturing Practices

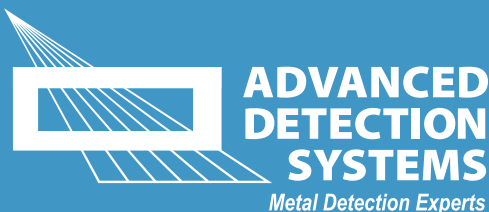

Understanding the Basics of
Metal Detection Systems.

phone: 414-672-0553 | www.adsdetection.com

Table of Contents

Home– Table of Contents	1	Detector Performance	10
Metal Detection– The Basic Principles	2	Reliable Reject Device	10
Why Use Metal Detection?	2	Reject Device Testing	11
Theory of Operation	2	Other Considerations	11
Balanced Coil	2	Gravity Drop/Drop-Through Metal Detectors	11
Balance Stability	2	Design Issues	11
Ferrous in the Foil	2	Determine Internal Pipe Dimension	11
Product Effect and Phasing	3	Round versus Rectangular Pipes	11
Product Effect	3	Overall System Length	12
“Phasing Out” Product Effect	3	Testing	12
Metal Free Zone	4	Automatic Testing	12
Sensitivity	4	Other Considerations	12
Types of Metal	4	Static	12
Ferrous:	5	Pipeline Metal Detectors	13
Non-ferrous:	5	Design Issues	13
Non-magnetic stainless steel:	5	Determine System Length	13
Shapes and Orientation of Metal	5	Selecting the Valve Style	13
Setup and Multiple Products	5	Selecting the Non-Metallic Pipe	13
The Four “P”s of Metal Detection	6	Testing	13
Preventing Contamination	6	Automatic Testing	14
Profitable Production	6	Inverse Detection	14
Protecting Customers	6	Good Manufacturing Practice – Guidelines	14
Promoting Brand Confidence	6	Prevention	14
Testing Metal Detector Performance	7	Testing	15
Metal Test Sample	7	Establishing operating sensitivity performance	15
Test Frequency	8	Documenting the sensitivity standard	15
Test Procedure	8	Number of tests	15
Test Records	8	Rejected Product Handling	15
Automatic Test Systems	8	Documenting the Program	15
Sources of Interference	9	Minimal Requirements and Verification	15
Applications	9	Appendix List	16
Conveyor System– End of Line	9	Appendix A – Typical Processing Line	16
Design Issues	9	Appendix B – Reject Devices	17
Sanitary Issues	10		

Metal Detection: the Basic Principles

Why Use Metal Detection?

Metal detectors are protection. They protect processing equipment, the products people consume, your companies brand image, and liability due to contaminated product.

Metal detectors are both effective and inexpensive. Processing and packaging equipment, such as crushers, extruders, shredders, cutters, grinders, choppers, mixers and the like are often expensive and susceptible to damage from metal contaminants. They can be expensive to repair and the price of downtime adds up quickly.

** See information about metal detector placement in Appendix A.*

Although 75-80% of metal detectors are used in food related industries. They are not the only industries who find the protection they offer useful. Aggregate, mining, rubber, plastic, wood, textile, glass, product and environmental security companies rely them as well.

Metal Detector Usage Can be broken into three main categories:

- ◇ **Packaging**– where higher sensitivity to the smallest piece of metal and product purity is desired.
- ◇ **Bulk Processing**– where gravity drop or pipeline metal detectors are used to defend processing equipment.
- ◇ **Industrial**– where industries (mining, aggregate plastic, rubber, lumber, etc.) have lower sensitivity requirements however, processing equipment must be protected from damage and downtime caused by larger tramp metal.

Theory of Operation

Balanced Coil

All metals are either magnetically conductive, electrically conductive or both. When they enter an electro-magnetic field they create a detectable disturbance or “signal”. Modern metal detectors operate on the balanced coil, full loop system which allows detection of this signal.

A balanced coil consists of three coils looping inside a static shielded head that has a built in aperture through which product passes. The head houses a transmitter coil that broadcasts a radio frequency signal and generates an electro-magnetic field. On either side of the transmitter are two equidistant receiver coils.

Signals from the receiving coils are connected in opposition to each other and when no disturbance is present, the net signal across the coil is zero. They are balanced. It is the electrical equivalent of a balanced weight scale.

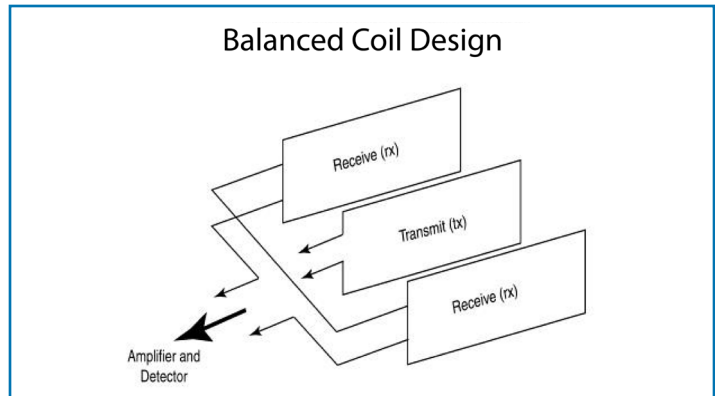

This balance is disturbed as metal contamination enters the aperture. The control electronics amplify and analyze the disturbance, then indicate a “detection” if the signal is greater than an established sensitivity threshold.

Balance Stability

Very small movements in the mechanical construction of the metal detector can also disturb the balance of the three coils. These movements can cause the detector to indicate that metal is present when it is not (Called “False Triggering”), or they can cause the loop to remain out of balance and continuously “false trigger” and require re-balancing. Metal detectors which require or are prone to vibration provide little value to automated production lines.

Movement can be caused by expansion of the detector from changes in temperature, vibration from nearby equipment causing the detector to vibrate, instability in the detector’s construction, and other causes. Robust construction, as well as good electronics, can prevent such movement and make the detector more sensitive. Good electronics design includes automatic balance control as part of its standard features. Good mechanical design includes enhanced potting techniques to minimize false triggering. Together they combine to increase reliability and effective sensitivity.

Ferrous in Foil

The coil balanced, full loop design does not work well when a product is packaged in foil (pure aluminum). Foil lids and trays are common examples where an alternative system is required. In these situations, the detector uses a series of magnets and is referred to as a “Ferrous in Foil” detector. Non-ferrous and stainless steel contaminants

Product Effect and Phasing

cannot be detected with this type of detector. Not only are all metals either magnetically and/or electrically conductive, but inspected products can also have one or both of these characteristics. Metal detectors “see” two signals when contaminated product passes through the aperture. One signal comes from the metal which contaminates the product. The second signal comes from the product. The signal from the metal must be greater than the signal from the product to trigger a detection.

Product Effect

Metal detectors measure electrical conductivity and magnetic permeability. Many inspected products inherently have one or both of these characteristics. For example, iron-enriched products (e.g. cereals) create a large magnetic signal that hampers the detector’s ability to detect the magnetic signal of small pieces of metal, and are commonly called “dry” products. Conversely, products with high moisture and salt content (e.g. bread, meat, cheese, etc.) are electrically conductive and produce a conductive error signal, and are commonly called “wet” products. The table below shows typical product error signals and categorizes them as conductive or non-conductive.

Typical Conductive Products:

- ◇ **Food:** meat, cheese, bread and bakery products, fish, dairy products, salads
- ◇ **Packaging:** metalized films
- ◇ **Other:** plastic and rubber products with high carbon black content

Typical Non-Conductive Products:

- ◇ **Food:** cereal, crackers, flour and powders, biscuits, frozen food products (<10oC), peanut butter and margarine (vegetable oil is not conductive)
- ◇ **Other:** wood products, plastics and rubber (products with high carbon black content may be considered conductive), textiles, paper products



Product effect may change as characteristics such as temperature and salinity change, but product aging may also affect it. Product definition may differ between the metal detector and the people producing it. For example, whole, frozen cheesecakes have a different product effect than sliced, frozen cheesecakes of the same ingredients. Those same cheesecakes may have different a product effect immediately after they emerge from a freezing tunnel than they do after sitting twenty minutes on a conveyor line.

“Phasing Out” Product Effect

At this point, we have signals from product, large pieces of metal, small pieces of metal, and vibration all vying for the attention of the detector. We also have varying product signal because each product is not exactly the same as the last. To identify a metal contaminant, the detector must remove or reduce this “product effect.”

An unfortunate “fix” commonly used is to reduce the sensitivity of the detector. Although this makes the signals from the product smaller, but also makes the signals from the metal contaminant smaller. This can make practical detection of metal almost impossible. Signals from ferrous metal are larger than signals from the same size piece of non-ferrous or stainless metal. Signals caused by vibration are always along the same lines as non-ferrous metals. Special circuits can be used to amplify the signals by differing amounts, according to phase, to improve sensitivity of the metal detector to the stainless signal, and reduce the sensitivity to vibration.

The detector can be adjusted to “rotate” the signals from the product in a way that maps out an area where the product is expected to be. This allows the product to be “ignored” and emphasizes analysis of signals outside that area to identify metal contaminant. The technique to create this “detection envelope” is called “product compensation” or “phasing-out” the product effect.

As noted above, product effect is caused by various factors and does not always generate the exact same signal. The “detection envelope” must be large enough so a product signal is normally within the envelope. Metal contaminate generally produces a different signal which would not appear within the “detection envelope,” and the detector would trigger for product reject when it sees the signal.

The mask of the “detection envelope” focuses analysis on signals outside of where product is expected to be. Some small pieces of metal will not provide a large enough signal to be detected outside that envelope and will pass through the detector without rejection. These pieces are usually smaller than the size specified for detection. Some product will have a signal greater than what is expected and will be rejected even

though no metal is present because of variation in the production process. Some product with no metal may be rejected because vibration in the system creates a signal seen outside the envelope.

Product testing and accurate specification of contaminant are essential to determine the detector's sensitivity and product effect. This service is usually available from the metal detector manufacturer.

Creating the "detection envelope" requires experience to achieve optimum performance. If several products are running on one production line, adjusting the detector for each product can be inconvenient and time-consuming. Fortunately, this experience can be programmed into the detector.

When a detector has an automatic product compensation feature, product which is known to have no metal contamination is passed through the detector in its "learn" mode. The detector's software analyzes the signals and calculates the "detection envelope" for that particular product. The settings can be saved so an operator can recall those settings the next time the product is run.

Automatic product compensation removes the effect of product variations that reduce sensitivity

***Diagram of Metal Free Zone**



ProScan Pipeline Head

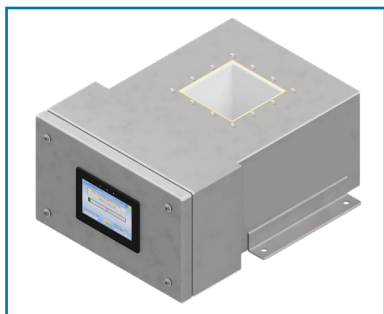

ProScan Gravity Drop Head

Metal Free Zone

The electro-magnetic field is created inside the detector's enclosure; however, some field emanates out of the aperture on both sides and forms the metal free zone ("MFZ"). Generally, the practical size of the leakage is 1½ times the (smaller) aperture dimension, and no metal should be allowed in this area. Large moving metal should be kept 2 times away. Special detectors are available for applications which demand a substantially reduced MFZ.

Sensitivity

In theory, aperture size determines the sensitivity of a given metal detector. Smaller apertures generally allow smaller pieces of metal to be detected. The smaller dimension of rectangular apertures is used to calculate the sensitivity, although the length also contributes.

The smallest size aperture should be selected to maximize the sensitivity of a detector, however, there are some exceptions including metalized film and highly conductive product (e.g. large blocks of cheese).

The center of the aperture is the least sensitive point of the metal detector.

Sensitivity is also affected by the position of the contaminant in the aperture. The least sensitive point is the centerline axis of the aperture (1 in diagram), and this is where to test performance. As metal gets closer to the sides (and the coils), the signal it generates gets larger, making it easier to detect (2 and 3 in diagram).

Regular testing of the detector should ensure the test sphere passes close to the center of the aperture. If this is not practical, a consistent position should be used so test results will be consistent.

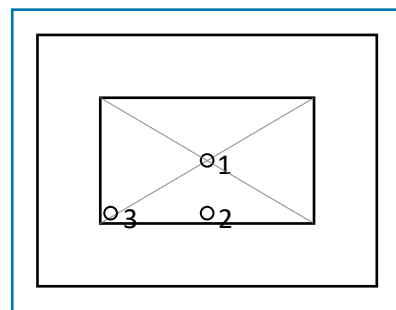

Types of Metal

Metal detector sensitivity is not the same for all types of metal. The ease of detection depends on how easily they are magnetized (the magnetic permeability), and the electrical conductivity of the metal. Metal detectors are calibrated for sensitivity to ferrous metals, non-ferrous metals, and stainless steel.

Ferrous:

Ferrous materials are any metal easily attracted to a magnet (e.g. steel, iron, etc.). Typically, ferrous metals are easiest to detect and usually the most common contaminant outside of food processing plants.

Non-ferrous:

Non-ferrous materials are highly conductive non-magnetic metals (e.g. copper, aluminum, brass, phosphor bronze, etc.). When inspecting non-conductive products, these metals produce almost the same size signal as ferrous metals because they are all good conductors. When inspecting conductive products, increasing the test sphere size by at least 50% is a good practice.

Non-magnetic stainless steel:

High quality 300 series stainless steels (e.g. Type 304, 316, etc.) are the most difficult metals to detect due to their poor electrical conductive qualities and, by definition, have low magnetic permeability. These are commonly used metals in the food processing and pharmaceutical industries.

When inspecting non-conductive products, a stainless steel test sphere typically needs to be 50% larger than a ferrous sphere to produce the same size signal. When inspecting conductive products, a stainless steel test sphere needs to be 200% – 300% larger than a ferrous sphere to produce the same size signal.

When detection specifications include non-ferrous and/or stainless steel, the particular metals, and sizes should be identified. Correct identification of what particles should be detected is critical because these metals have many varieties and they all look slightly different to the metal detector.

Shapes and Orientation of Metal

Metal detection standards are based on spheres because spheres are the same shape from any angle. Real contaminants are rarely spherical and may produce a different signal depending on its orientation when passing through the detector. Wire contaminants are the most dramatic example of this.

The signal produced by wire shapes varies greatly depending on the type of metal and its orientation as it passes through the aperture. In its worst case, a wire may produce a signal no bigger than a sphere of the same size as the diameter of the wire.

The following diagram shows that configuration “A” provides the biggest signal (easiest to detect), in ferrous-type wires, while configurations “B” and “C” provide the smallest signal (most difficult to detect). Similarly, in non-ferrous and stainless steel wires the opposite is true (i.e. “A” provides the smallest signal and “B” and “C” provide the biggest signal).

Setup and Multiple Products

Detectors which are difficult or complex to set up are generally not programmed correctly. Well-designed detectors’ basic instructions will allow changes to be made correctly and easily. Many detectors have “automatic setup” features which could approach what could be achieved by an experienced operator; however, if improperly used there can be a significant decline in the detectors performance. While having a different product setting for each product may be appropriate, more operator choices can mean more opportunity for incorrect selection (see the “Product Effect” example of cheesecake above). Grouping similar products under one product setting may provide easier and more accurate inspection (e.g. 12 oz. rice patties with 8 oz. rice patties).

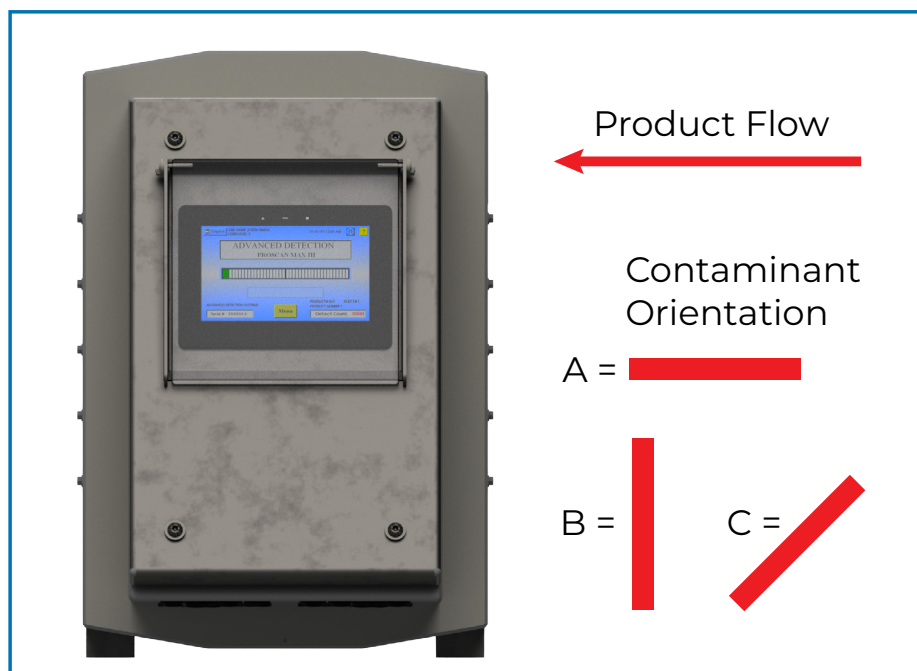

* Diagram of contaminant orientation

The Four “P”s of Metal Detection

Preventing Contamination

Metal in product can be a cause of consumer complaints even with metal detection systems in operation. The complaints (which usually do not include visual items such as bolts, washers, and pieces of blades or screens found in product) are usually due to lack of effective controls, poor working methods, and incorrect specification (and therefore design) of the system rather than actual failure of the metal detector.

Effective metal detection programs focus on minimizing contamination through good manufacturing practices (“GMP”), proper equipment selection, effective testing, and ever-improving knowledge of how industry standards, customer requirements, and legislation affect manufacturers.

The four “Ps” describe why metal detection is critical for processing or packaging lines

Effective metal detection programs focus on minimizing contamination through good manufacturing practices (“GMP”), proper equipment selection, effective testing, and ever-improving knowledge of how industry standards, customer requirements, and legislation affect manufacturers.

Profitable Production

The cost to implement and maintain an effective metal detection program is significantly lower than the potential cost of metal contaminate being found in the product. Metal contaminated product found before shipment may result in product and packaging waste, possible machinery damage, and loss of output. Metal contaminated product found after shipment can affect customers, cause product recalls, create adverse publicity toward your company or brand, create financial liabilities, and potential litigation. An appropriately implanted metal detection program will lead to reduced failure costs, improved customer and consumer satisfaction, protects profitability as well as your company or brand.

Protecting Customers

Manufacturers have a legal and moral obligation to their customers to minimize contamination of their product and ensure consistent quality. They are responsible for taking steps to protect their product’s quality and the welfare of the consumer. Today’s manufacturers incessantly look for ways to eliminate contamination in their products, yet processes or procedures, or compliance with them, break down and product becomes contaminated. Failure to do this can be costly.

Promoting Brand Confidence

Branding not only helps maximize sales, but also generates customer perception of product safety and quality, and drives repeat customer purchases. Product brands are valuable, important assets which must be protected. Contaminated products reaching the consumer can have financial consequences by product recall, from potential litigation, and can damage a brand or reputation which has been built and consumed significant company resources. Accurate documentation of compliance with production standards can help minimize damage from customer complaints.



Testing Metal Detector Performance

When unwanted metal can be introduced into a product, a metal detection system is a necessary control measure and should be considered a Critical Control Point (“CCP”). Regardless of how sophisticated or reliable a metal detection system may be, it is only as good as the frequency and thoroughness of testing and recording programs supporting it. Testing and recording are essential components of any quality HACCP (Hazard Analysis and Critical Control Points) system. In the absence of any industry standards for detector testing, each company must establish their own test criteria.

The HACCP plan should be validated before implementation, re-validated annually, and verified frequently. Validation is the assessment of its scientific and technical aspects and that the hazards, critical limits, monitoring, and corrective actions have been properly established. Re-validation is needed to ensure the plan continues to be valid after considering changes in processing or manufacturing methods. Verification determines if the plan is adhered to and is being properly administered. Verification can include review of the application of methods, procedures, tests, and other evaluations in addition to monitoring, to determine compliance with the validated plan.

Identifying and rejecting contamination as early as possible within the manufacturing process is consistent with good manufacturing practices (“GMP”), and is a HACCP pre-requisite. HACCP does not rely solely on product testing to ensure safety, but builds safety into the entire manufacturing process. Contamination or hazards are reduced or prevented by relying on controls in the process.

When creating or changing your testing program, consider the following points:

Metal Test Sample

Historically, metal detectors have been tested with a ferrous and non-ferrous, and sometimes a stainless steel test sample.

The size of the test sample must be established so that it can be reliably detected inside product passing through the detector, down its centerline – the least sensitive point.

Every application will be different and samples should be matched to each application and detector. Samples too small for the application will cause unnecessary test failures, and create frustrated test operators. If the sample is too large, the performance of the detector will not be accurately tested. Establish a realistic, repeatable operating performance level using a selection of test sample sizes. Then choose an appropriate test sample(s) for testing each application type.

Typical Guidelines for Sensitivity:

Aperture Height	Non-Conductive Product	Conductive Product	
	Ferrous & Non-Ferrous	Ferrous	Non-Ferrous
Up to 2 in. (50mm)	1.0 mm	1.5 mm	2.0 mm
Up to 5 in. (125 mm)	1.5 mm	2.0 mm	2.5 mm
Up to 8 in. (200 mm)	2.0 mm	2.5 mm	3.0 mm



Test Frequency

Management must decide the frequency of testing the detector. Typically, detectors are tested after repair or maintenance of the equipment, at a shift change, when product changes, or on an hourly basis.

Test Procedure

Keep test procedures as simple as possible, but should include the following:

- ◇ Test samples should travel through the approximate centerline of the aperture which is the least sensitive point.
- ◇ Test samples should be placed within the product, if possible.
- ◇ Test procedures must allow the reject device to activate to test the entire system. This can include:
 - Testing with contaminant at leading and trailing edge.
 - Testing successive packs.
 - Testing alternate packs.
- ◇ The results of the test must be recorded.

Test Records

A sample of a test record is included for information. The format is not important but should include:

- ◇ Line or detector identification
- ◇ The date and time of the test
- ◇ The sample used
- ◇ Identification of the operator
- ◇ The result of the test (pass, fail, etc.)
- ◇ Corrective action taken if the result was failure.

Automatic Test Systems

Automatic test systems have been developed to compliment, and in some applications replace, manual test procedures. The capability of these systems should be reviewed carefully to ensure that the testing is relevant and feasible for the application. When installed effectively, they can offer considerable savings through reduced labor and material waste associated with manual test procedures when a facility has difficult to access gravity drop or a high number of metal detectors in service.

ADVANCED DETECTION SYSTEMS®
"Metal Detection Experts"
• 4740 W. Electric Ave. Milwaukee, WI 53219 P: (414) 672-0553 • www.adidsdetection.com • Engineered & Manufactured in USA •

Metal Detector Verification

Pursuant to our service call on _____, we are please to verify the following test results for your metal detector.

Make	Model	Serial #	Aperture Size
			_____"H x _____"W

The following Certified Test Samples were verified and detected successfully three (3) times in succession:

_____ mm	Ferrous Metal Test Sample	Certification #: _____
_____ mm	Non-Ferrous Metal Test Sample	Certification #: _____
_____ mm	316 Stainless Steel Metal Test Sample	Certification #: _____

Inspection

The following performance metrics checked to validate the metal detector is able to reliably meet the requirements set forth by: _____
(Company Name)

Pass	<input type="checkbox"/>	Fail	<input type="checkbox"/>	*Stability. Environmental factors and uncontaminated product does not trip the metal detector
Pass	<input type="checkbox"/>	Fail	<input type="checkbox"/>	*Sensitivity Check. Passing test wands no less than three (3) times, making sure there is proper detection and rejection of the metal contaminants.

Customer Signature _____ Date _____

Verification Completed By _____ Date _____

**Make 2(two) copies of this Metal Detector Verification form. Give 1 (one) copy to the customer and include the other copy in the email to Advanced Detection Systems (see Verification Service Procedure document).

Advanced Detection Systems
"Metal Detection Experts"
Identifying and Meeting Unique Metal Detection Needs for Over 30 Yrs.

Metal detector verification documentation

Sources of Interference

Environmental conditions may affect the performance of the metal detector, particularly where high levels of sensitivity are to be achieved. Wherever possible, the detector should be positioned to avoid or minimize the effect from such conditions. These can be generated by a number of sources:

- ◇ Airborne electrical interference – static, radio, earth loops, etc.
- ◇ Vibration – moving metal
- ◇ Temperature fluctuation – ovens, freezers, etc.

While the detector may be capable of filtering some of this interference out through such features as “Automatic Balance,” in many cases the only option is to reduce the sensitivity level. This is an important consideration when comparing the capabilities of detectors.



Applications

Conveyor System– End of Line

End of line metal detection is generally the preferred option as at this point product has been packaged and there is no further risk of contamination. This is not always feasible for many reasons including:

- ◇ Physical restrictions – no space available
- ◇ Packaging type/material – foil lids or trays
- ◇ Package size – too large for detection standard
- ◇ Critical points – machinery protection or raw ingredients

Design Issues

The conveyor's purpose is to move product through the detector's aperture and successfully reject contaminated product. To achieve optimum performance from the system, several design issues should be considered.

The conveyor design must avoid interfering with the detector in any way. Both the conveyor and reject device affect the performance of the metal detector. Eddy current loops (often called “ground loops”) and static electricity build-up can occur unless precautions



Metal detector with Welded Conveyor System.
Ideal for Bulk Product or Wet Process Conditions



Metal detector with Bolt-Together Conveyor System.
Ideal for Packaged Product.

are implemented during the design phase. These can interfere with the detector and reduce the sensitivity of the unit.

Metal detectors create eddy currents loops by emitting high frequency signals in the aperture. Those frequently “spill over” to the surrounding conveyor construction. They do not affect the detector if they remain constant. They can briefly change if the conveyor has an intermittent joint of variable resistance, and then the eddy currents create a large interference signal, which the detector can read.

Eddy current loops are typically created by any metal-to-metal contact (e.g. bolted items, pulley shafts and bearings, chain drives and guards, reject supports and metal clamps, etc.) Rusting joints or changes in bearing lubrication can cause problems to increase over time. Reliable performance is enhanced by fully-welded structures, correct metal free zones, and properly isolated rollers, pulleys, cross-structures, and detector head mounts. Conveyor belting must be metal-free as well as having appropriately contaminant-free joints. Avoid anti-static belting material because it can create signals which reduce detector performance.

When these factors are not given adequate consideration during design, the common outcome is a gradual increase in false triggers and false rejects. This is often “fixed” by reducing the detector’s sensitivity. This “fix” can violate customers’ inspection requirements and be more expensive than appropriate corrective action.

Sanitary Issues

All metal detection systems’ design must consider the operating environment and cleaning routines they are likely to encounter. Eliminating dirt and bacterial traps, sealing hollow sections, minimizing horizontal surfaces, providing easy access for maintenance and

testing procedures, designing an easy-to-clean system, and following regulatory guidelines are essential when sanitary concerns apply.

Detector Performance

Manufacturers will generally supply recommendations for achieving the best performance from the metal detector. Always apply these recommendations;

- ◇ Isolated rollers – to prevent ground loops
- ◇ High quality belt – metal free, interlocked finger joints, plastic modular belt
- ◇ Low vibration and static-free area
- ◇ Adequate metal free zone.

Reliable Reject Device

The selected reject device must be suitable for:

- ◇ Package size, weight, and shape
- ◇ Presentation pitch, line speed, and belt width.

The following table provides general guidelines as to which reject device will be best suited to your application. The figures may vary slightly with the manufacturer. Diagrams of the reject devices are in Appendix B.

Consider the following additions to ensure reliable rejection of contaminated product:

- ◇ Registration photo eye – to ensure correct timing
- ◇ Enclosed area from detector to reject device – to avoid pack removal
- ◇ Lockable bin – to ensure contaminated packs are quarantined

Type	Suited for	Max Wt	Notes
Air blast	Light consumer packs (i.e. biscuits, chocolate bars, etc.). High throughput.	2 lbs. (1 kg.)	Unsuitable for loose product, boxes, curved surfaces, and some bagged product.
Divert arm	Medium to light packs. Medium throughput.	10 lbs. (5 kg.)	Product generally enters bin diagonally– must ensure it will fit!
Push arm	Medium packs. High throughput.	15 lbs. (7 kg.)	Unsuitable for loose or fragile product.
Stop on detect	Large bags or boxes, hand fed or bulk material. Slow throughput.	50 lbs. (25 kg.)	Requires an operator to remove contaminated product.
Retracting pulley or Flop gate	Small product in lines or irregular shape. Medium throughput.	5 lbs. (2 kg.)	Dimensions are for whole line or batch of products.

Reject Device Testing

Complete system functionality should be tested as well as ensuring the metal detector is functioning correctly. This involves ensuring that the reject device is operating correctly and contaminated product is correctly handled.

Reject device testing is generally proved by observing contaminated product that is quarantined after:

- ◇ Placing the test piece at the leading edge of the product
- ◇ Placing the test piece at the trailing edge of the product
- ◇ Passing successive test packs

Passing alternate test packs.

Other Considerations

Additional fail-safe methods can be incorporated into the system design, in addition to regular manual testing, including:

- ◇ Reject confirmation/Bin full sensors
- ◇ Air pressure failure sensors
- ◇ Fault/Shutdown.

Gravity Drop/Drop-Through Metal Detectors

On the surface, the gravity drop application of metal detector is very simple. However, care must be taken in the initial design to avoid having to make major modifications after installation. Many design concerns (and solutions) for systems with conveyors are applicable for all systems. Consider all of the following steps when designing a gravity drop detection system.

Design Issues

Gravity drop detection systems are ideally suited to inspecting dry, free-flowing products such as grains, flours, cereals, rice, nuts, sugar, plastic pellets and flakes, as well as in vertical packaging applications, liquids, pastes, and slurries. The product must remain free flowing and not back up into any part of the system. Support structures and reject devices can reduce metal detector effectiveness if not designed properly.

Determine Internal Pipe Dimension

Existing piping often determine the pipe and detector size. This formula is useful if you know the peak expected flow rate of the product and its density:

$$\text{Area of aperture required (in}^2\text{)} = \frac{0.024 \times \text{Flow rate (\#/hr)}}{\text{Bulk density (\#/ft}^3\text{)}}$$

Example: A product with a flow rate of 20,000 #/hr and a bulk density of 18 #/ft³ will require a calculated pipe area of .024 X 20,000 / 18 = 26.7 in².

Round versus Rectangular Pipes

Round pipe will utilize the pipe area required for product flow more efficiently than a square or rectangular pipe and therefore the flow capacity of rectangular pipes should be de-rated by at least 20%.

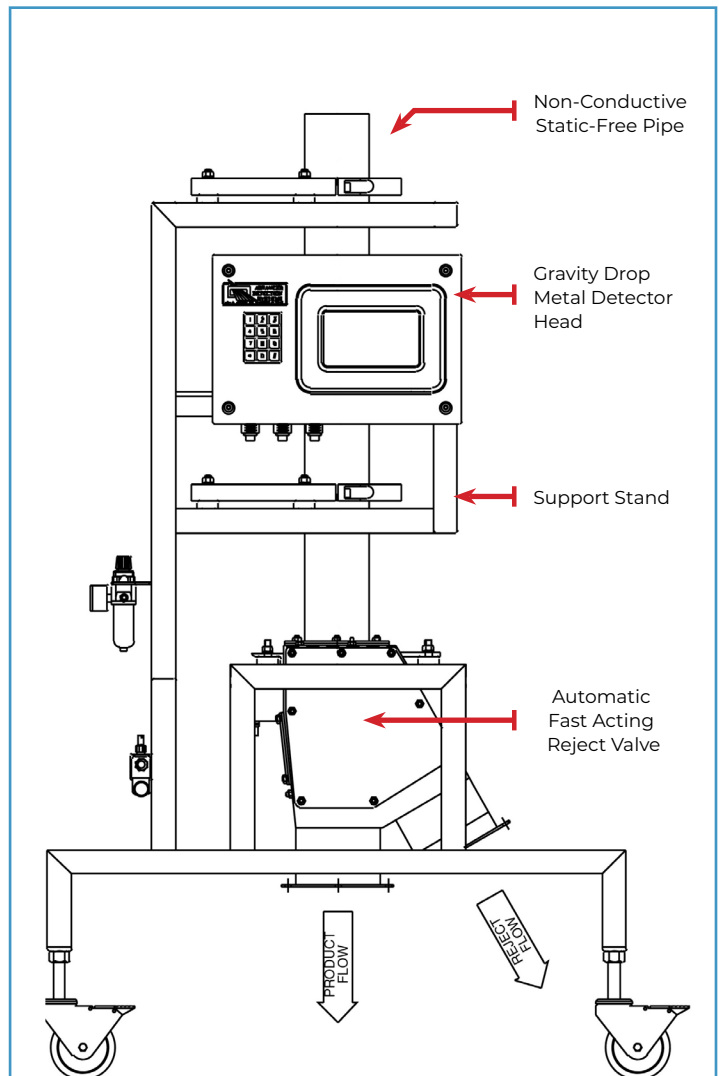

Overall System Length

After establishing the proper pipe size, the overall system length can be considered. The bigger the pipe's internal diameter ("ID") the longer the system must become. The detector through dimension must increase as aperture size increases, the valve height will also increase due to the increased stroke, and the required distance between the valve and the detector must increase. The latter is due to the larger valve taking more time to reach full divert position and therefore it must be located further from the detector.

The relationship between the valve response time, product free fall height, and system length is very important. Correct design relies on knowing the product pipe size (see above), the valve response time (from the manufacturer – bigger valves require more time), and product free fall distance from initial drop to the centerline of the detector.

If the free fall height is increased, the distance between the detector and reject device must be increased in order to maintain adequate time for the reject device to respond. Small changes in the detector-to-reject device distance can substantially affect the maximum allowable free fall distance because the product accelerates at 32 ft/sec² as it falls.

For example, given a reject device response time of 40 ms and a detector-to-reject device distance of 10 in., the calculated maximum free fall would be 19 in.. If the reject device was moved 3 in. closer to the detector (to 7 in.), the maximum free fall would be 14 in.

Testing

Gravity drop detectors can be very difficult to test. Testing can be performed quickly and reliably if testing access and recovery are designed into the system. The test procedure must confirm the detector's performance as well as the response of the reject device.

A test access port is required for test access. This port allows the introduction of a test sample (a plastic ball with a metal sample embedded) where the product free fall starts. The port should allow the test sample to fall such that the test sample speed matches the speed of the product during production.

A test sample safety retrieval gate is required for test recovery. This port should be inserted into the normal product flow below the valve where "good" product flows following testing. This allows for safe recovery if the detector fails to detect the sample or the reject device fails to perform properly.

Well-designed systems allow test samples to be quickly inserted into product flow during testing and removed from product flow after testing.

Automatic Testing

Perform manual tests upon initial installation and at reasonable time intervals afterward. An automatic test system can offer both consistent and relevant testing, if correctly designed into the system.

Other Considerations

Static

All falling dry powders and granules generate static electricity. Some are more prone to this than others, and environmental conditions (lack of humidity) can increase static electricity levels. Consider the following measures to reduce static damage and interference;

- ◇ Ground all metal near the detector system (pipes, flanges, structural supports, etc.) to avoid accumulating static electric charges.
- ◇ Wrap conductive shields around plastic parts (product tubes, etc.) to help dissipate static electric charges. Grounding standard (non-conductive) will not eliminate static. Some conductive plastics are available for food use but may interfere with the detector.
- ◇ Use a major single point ground for the detector itself (consult the manufacturer for their recommendations). Detectors using remote power supplies may be more susceptible to damage.
- ◇ An ionizing anti-static device may also be useful.

Excellent sensitivity and early warning of product contamination can be obtained by gravity drop metal detectors through careful design, accurate information, and consideration of critical parameters early in the design phase of the system.

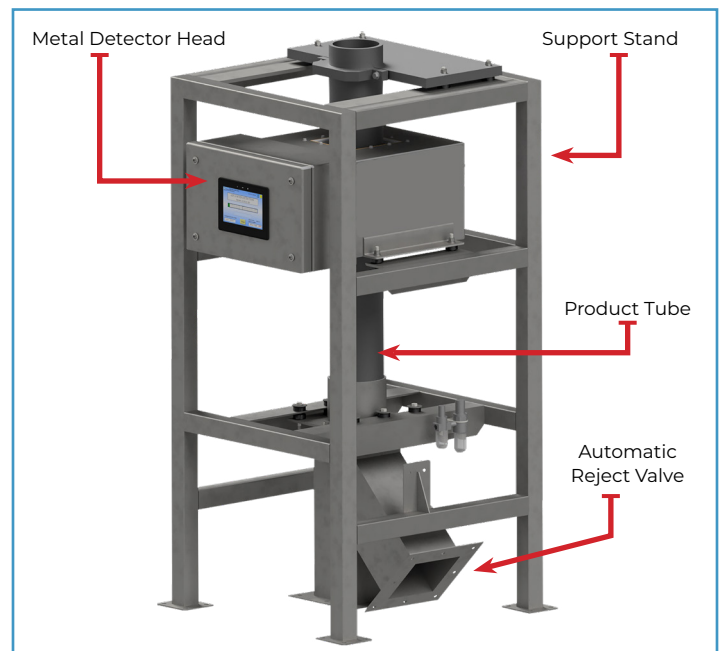

* Gravity Drop metal Detector System

Pipeline Metal Detectors

Pipeline applications involve the installation of a non-metallic pipe section that sends product through a metal detector for testing. Pipeline applications are used where the extra sensitivity of a small aperture outweighs the benefit of final package inspection. An example would be testing soup before it reaches a packaging line using metal cans.

Pipeline systems are ideally suited to inspecting liquid, slurries, or paste products that can be pumped through a pipe. Such products would include sauces, dairy products, meat slurries, juices, etc

Design Issues

Designing a successful pipeline detection system relies on many critical factors, including the following:

- ◇ Internal diameter (“ID”) of pipe
- ◇ Pipe clamp connection style (tri-clamp, I-line, etc.)
- ◇ Product flow rate (GPM)
- ◇ Product viscosity
- ◇ Product temperature range
- ◇ Product pressure

- ◇ Expected cleanup procedures (wash down, pipe pig, etc.)

Determine System Length

The position of the reject valve relative to the detector depends on the product speed. The distance between the valve and the detector must be increased in direct proportion to the product speed and valve response time, since the valve has a minimum divert response time. Estimated product speed is measured in gallons per minute (“GPM”). An appropriate safety margin must be added to the speed calibration, due to laminar flow characteristics of liquid in a pipe, and the system must be rigorously tested at full production rates to ensure the valve can respond in time. For example, if a system uses

For example, if a system uses a 2 in. pipe with a maximum flow rate of 80 GPM, the average product speed will be 10 ft/sec.. If the response time for a 2 in. valve is 0.25 sec., the valve must be at least 2½ ft. from the detector, but, to allow for laminar effects, increasing the distance to 3 ft. would be recommended.

Selecting the Valve Style

Product temperature and viscosity influence valve selection. Some valves are best suited for low viscosity products such as juices, etc.

Selecting the Non-Metallic Pipe

Pipe selection depends on the required connection style, product temperature and, especially, the expected pipe pressure. Careful design is required to ensure the non-metallic pipe will not receive added pressure from the stainless steel piping.

Testing

Pipeline detectors can be very difficult to test. Testing can be performed quickly and reliably if testing access and recovery are designed into the system. The test procedure must confirm the detector’s performance as well as the response of the reject device.

A test access port is required for test access. This port allows the introduction of a test sample (a plastic ball with a metal sample embedded) upstream from the detector. The port should allow the test sample to travel such that the test sample speed matches the speed of the product during production.

A test sample safety retrieval gate is required for test recovery. This port should be inserted into the normal product flow below the valve where “good” product flows following testing. This allows for safe recovery if the detector fails to detect the sample or the reject device fails to perform properly. Installing a similar port on the reject output will allow easier recovery of rejected test samples. Test samples can be quickly inserted into product flow during testing and removed from product flow after testing in well-designed systems.

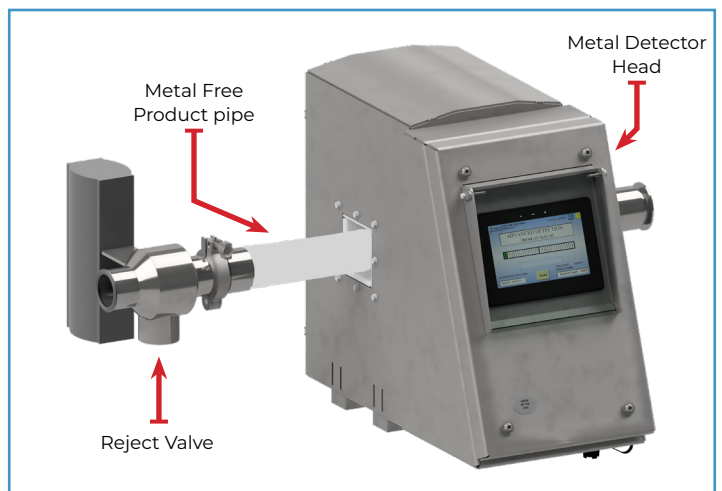
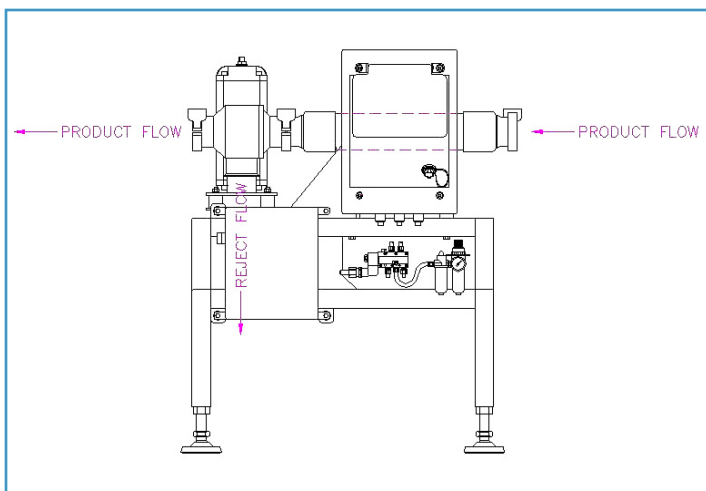

Automatic Testing

As with gravity drop applications, testing in pipeline systems does not allow placement of the test sample down the centerline of the detector's aperture, the least sensitive point. Consequently, test results may be inconsistent.

Automatic test systems can perform short-interval testing of the detector and valve reaction without operator involvement. Reject devices can employ a valve position switch, which returns a confirming signal to the detector, which can then monitor, or log, the reject device response time.

Inverse Detection

Detecting metal can also mean ensuring something you want is in a package. Reversing the reject device setup causes the system to reject product with no metal in it while accepting metal-containing product. Care is required to ensure that unwanted metal is not included before or between the point the desired metal item is added and the detector.

Good Manufacturing Practice – Guidelines

Every packaging and processing company must perform a hazard analysis for each product it produces to assess the risk of metal contamination. The analysis should identify potential sources of contamination and the types of metals involved. This information identifies the needs around which the metal detection system must be designed.

A producer of biscuits, for example, may identify potential risk in the following areas:

- ◇ Raw materials arriving from grain processing plants
- ◇ Combining raw materials together for mixing
- ◇ Cutting machines forming the biscuits
- ◇ Conveyors transporting product
- ◇ Packaging.

Contamination allowed to continue through the production process can pose a threat to processing equipment downstream and/or may break into smaller, more difficult to detect, pieces. This can increase scrap costs because processing costs have been incurred on product after it has been contaminated.

Establishing a GMP program in a processing environment minimizes the number of contaminants entering the production line.

Metal detection should be part of the normal product flow whenever possible to avoid potential confusion regarding what has been inspected, and prevent unintentional bypass of inspection processes. The end of each production line should be considered a "CCP," and the optimum inspection point is usually immediately after final packaging, or as close as possible to final packaging in the normal product flow.

When metal detection is impractical to perform on the finished package, alternative control systems must be created. When good product is manually removed from the conveyor to be hand-packed, guarding should cover and extend along the conveyor and reject system to prevent packers from taking packages before they pass the reject device.

Prevention

Personal effects and operational consumables present a contamination risk where poor awareness and lack of work practices exist. Minimizing contamination risk requires time spent on identifying potential risks, defining good work practices, and providing proper equipment. Continually implement, update, and communicate operating policies to ensure everyone remains informed and supportive of these practices. Extend these practices back along the supply chain to vendors.

The following are some examples of what constitute good manufacturing practices ("GMP"). Other specific control measures may be relevant to specific industries, companies and manufacturing processes, however, they effectively demonstrate risks which may easily be overlooked:

- ◇ Cover product-holding containers at all times
- ◇ Cover conveyor lines carrying open containers until they are closed or capped
- ◇ Do not use paper clips or staples on documents in production areas
- ◇ Do not use pins on notice boards in production areas
- ◇ Allow no hair clips, watches, or jewelry in production areas
- ◇ Avoid protective clothing with outside pockets
- ◇ Use only "metal detectable" pens, hairnets, hearing protection, and ancillary equipment so lost items can be detected.

Testing

Establishing operating sensitivity performance

Sensitivity performance should be maintained without need of operation attention. Unstable units which require constant attention, or reject good product due to false reject signals from plant vibration or other influences do not provide value.

The best achievable sensitivity depends on product type, size, and packaging materials, and should be selected in consultation with metal detector's manufacturer, in combination with test results of the product(s) being inspected.

Packaged product may contain detectable metal, even when it is free of staples or other metallic fasteners, and has been determined to be the cause of false reject signals.

Best achievable sensitivity should be established for each product being inspected. If a test sample's signal is large compared to that required to trigger detection (visible on the display panel of some detectors), there is a large safety margin for detection. This information can be used to determine how frequently the system needs to be verified.

Maintain records of sensitivity tests, and the results for each product, during technical, operational, and sanitary audits of the system.

Access to sensitivity adjustment controls should be limited to properly trained employees. Prevent access by others through password protection or lockout of the appropriate controls.

Documenting the sensitivity standard

Sensitivity standards should be expressed as the minimum detectable ball size and indicated by the nominal spherical diameter and material (e.g. 2.3 mm diameter type 316 stainless steel). The minimal detectable sphere size should be qualified in relation to the height of the metal detector's aperture, the product type, and application.

The sensitivity standard should be properly documented, effectively communicated throughout the organization, and readily available to appropriately trained verification personnel.

Number of tests

The quantity of samples required to test the metal detector system should be derived from confidence levels established when the system was designed and implemented. The system's capability to accurately and repeatedly detect metal should match those results is being tested. Tests indicating only marginal detection

(based on signal strength) may lead to additional testing which may eliminate questions about sensitivity and repeatability.

At least three tests per material type and aperture position are generally considered realistic for most testing purposes. When good detection capability has been established during implementation, fewer tests may be required as acceptable practice.

Statistical importance ultimately determines the number of tests for each sample type to satisfy requirements within the manufacturer's quality program, regulatory requirements, or customer demands.

Rejected Product Handling

- ◇ Isolate and re-screen potentially contaminated product on test failure.
- ◇ Investigate source of contaminant – trained personnel, off-line and within reasonable time.
- ◇ Identify the source of repeat detections contaminant.
- ◇ Stop production when multiple detections occur.

Documenting the Program

Document the metal detection program as a set of internally controlled policies and procedures supported by all employees in contact with product. The scope and detail of the procedures should be commensurate with the size, complexity, and lines of communication within the organization. The most effective programs are established, documented, operated, and maintained within the framework of a structured food safety management system supported by the management activities of the organization.

Relevant, meaningful documentation can be critical if your company is investigated because of a customer complaint. Documentation provides needed evidence of compliance with production practices in effect.

Minimal Requirements and Verification

Adopting a metal detection program should be a strategic decision for the company to avoid losing its importance and reducing support for its effective maintenance. The needs and objectives of the company, the products made, the manufacturing processes used, and the size and structure of the company should govern the system's design and implementation. The program should aim to control production through the supply chain to the final customer and support needs after shipment. The program needs to be proactive, and should help prevent contamination rather than merely detecting when it happens.

Your metal detector will require annual documented verifications conducted by a 3rd party. This helps ensure the purity of a company's product and provide protection of a company's brand. Verifications are required by government regulations, auditors, Hazard Analysis Critical Control Point (HACCP) plans and most food retailers.

Appendix List

Appendix A – Typical Processing Line

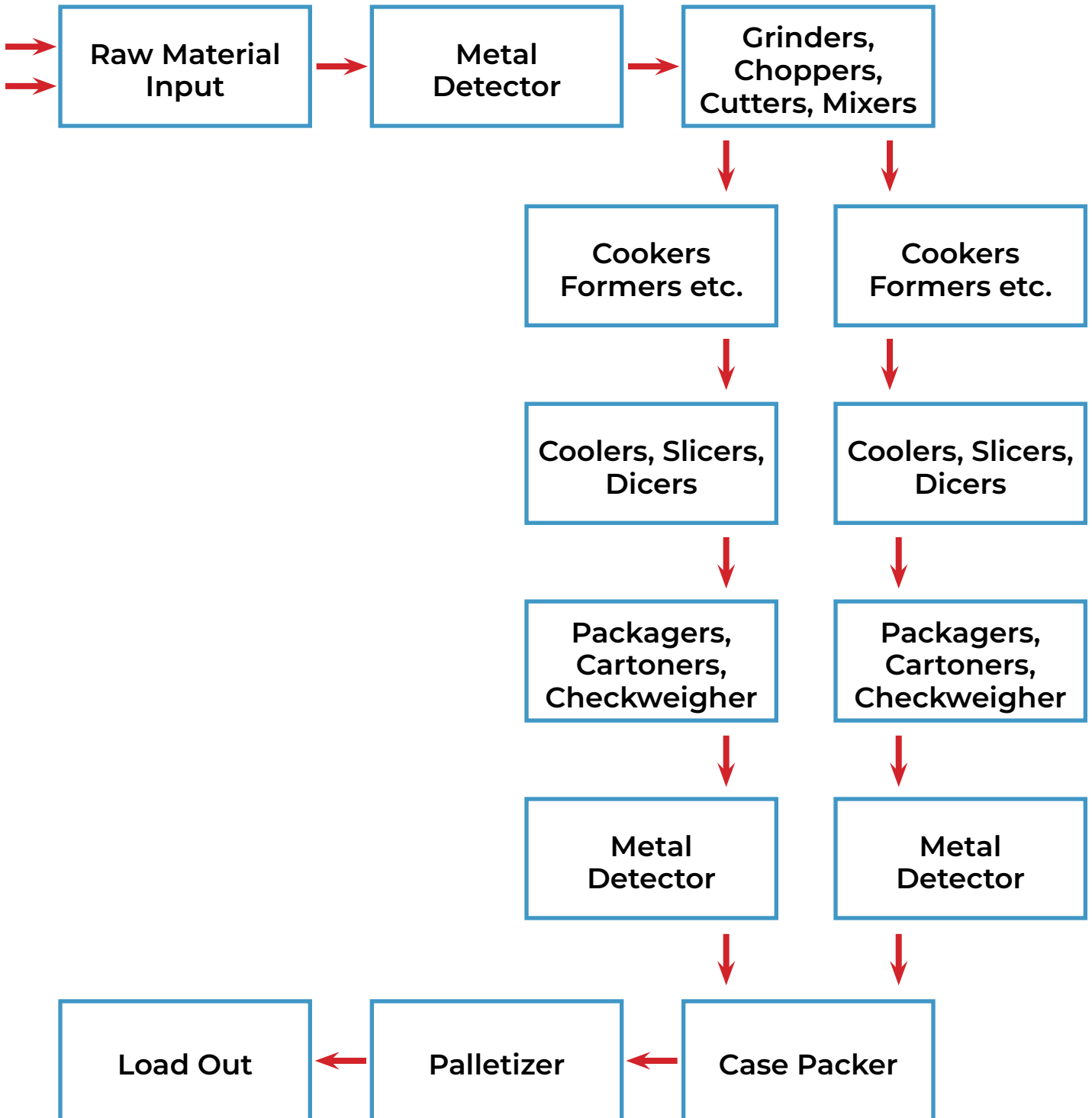

Appendix B – Reject Devices

Sweep Arm

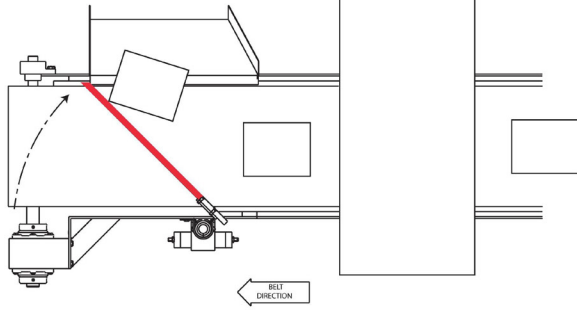

Divert Arm

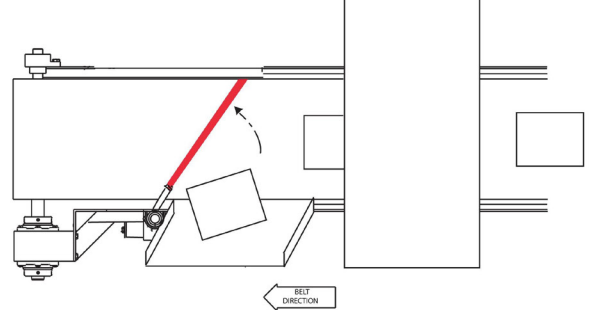

Air Blast

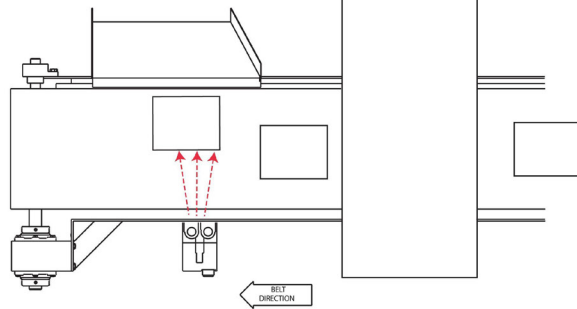

Push Arm (Ram)

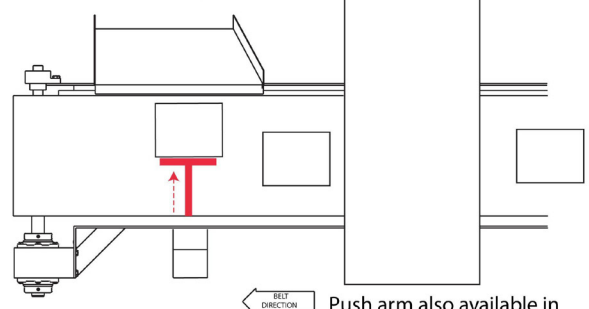

Push arm also available in alternate side design.

Retracting Pulley

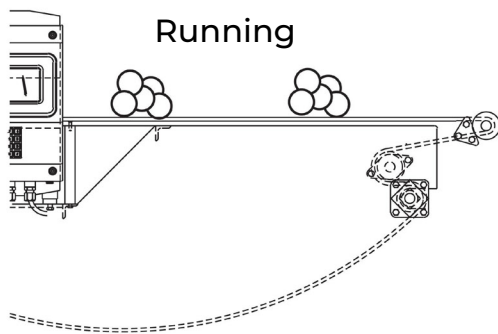

Running

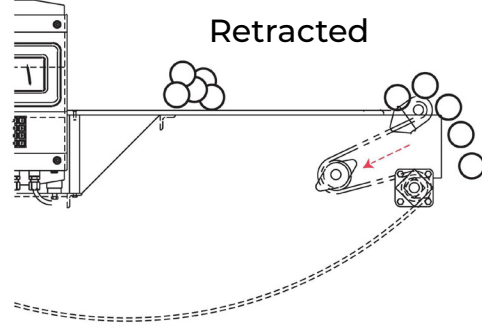

Retracted

Flop Gate

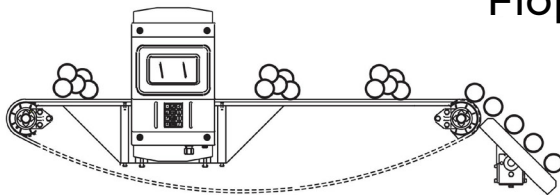

Running

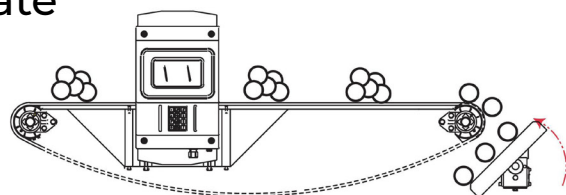

Retracted